



Features and Benefits

- Frequency range: 10MHz
- Supply voltage: 2.5V
- Current: 7mA Max.
- Output waveform: Clipped Sine
- Frequency stability vs. temperature: ± 0.25 PPM
- Aging: ± 1 PPM per year
- Phase noise: -152dBc/Hz@100KHz:
- Operating temperature: -20°C to +70°C
- Size: 5x3.2x1.7 mm

Typical Applications

- Portable Wireless Communications
- Mobile Test Equipment
- Radio
- SATCOM System

Description

TCXO5300BT-HS-10MHz_CS-1412 is the high stability and low phase noise small size TCXO. It can be widely used in the portable communication devise.

Mechanical Drawing & Pin Connections

Drawing No: MD150017-8

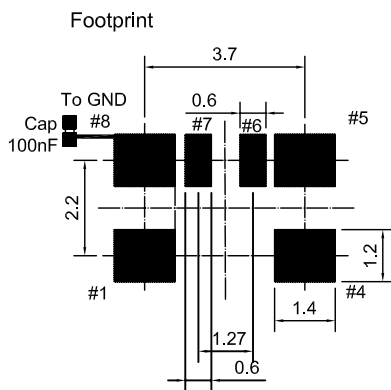
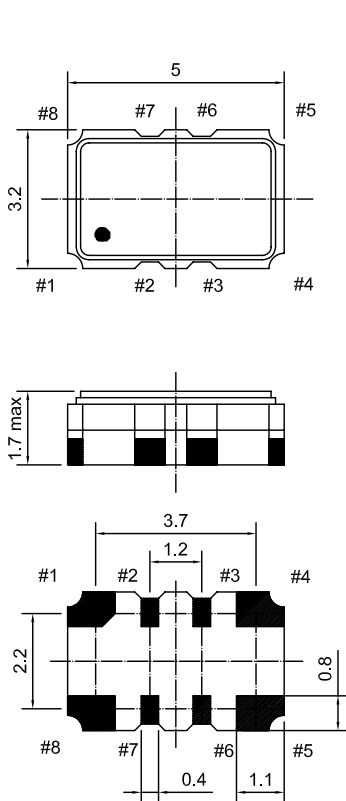

Pin Function

#1	Vc(EFC)*
#2	N.C. or GND
#3	N.C. or GND
#4	GND
#5	Output
#6	Tri-state or N.C.
#7	N.C.
#8	Vcc

*For control voltage version

Unit in mm
1mm = 0.0394 inches



Specifications

Oscillator Specification	Sym	Condition	Value			Unit	Note
			Min.	Typ.	Max.		
Operational Frequency	f ₀			10		MHz	
RF Output							
Output Waveform			Clipped sine				
Output Level			0.8			Vp-p	
Output Load			10K//10pF				
Tri-state function		PIN#6 high or open	Pin#5 oscillation				
		PIN#6 low or GND	Pin#5 high impedance				
Power Supply							
Voltage	V _{CC}	±5%		2.5		V	
Current					7	mA	
Frequency Control							
Control Voltage Range			0.5	1.5	2.5	V	
Tuning Range		Positive slope	±5			ppm	
EFC input impedance			100			Kohm	
Frequency Stability							
Tolerance		@+25°C			1.0	ppm	
Versus Temperature Reference to (FMAX+FMIN)/2					±0.25	ppm	
Versus Aging@+40°C		1 st year			±1.0	ppm	
G-sensitivity		Per axis			2.0	ppb/g	
Phase noise (typ.)		10 Hz		-83		dBc/Hz	For 40MHz
		100 Hz		-110			
		1 KHz		-135			
		10 KHz		-148			
		100 KHz		-152			
Environmental Conditions							
Operating temperature range		-20°C to +70 °C					
Storage temperature range		-55°C to +110 °C					
Reflow Profiles as per IPC/JEDEC J-STD-020C		≤260°C over 10 sec. Max.					

Note: Unless otherwise specified conditions are @+25 °C