



Features and Benefits

- Low phase noise
- Linear tuning characteristics
- Low pushing / Low pulling
- Aqueous washable

Typical Applications

- SATCOM Point –to-Point
- Receiver Radio
- Test Equipment MMDS
- Radar WiMax

Specifications

Parameter	Units	Min.	Typical	Max.
Operating Frequency Range	MHz	2612		2660
Output Power	dBm		5	
Phase Noise @10kHz offset	dBc/Hz		-111	
Tuning Voltage (Vt)	Vdc		1.5-8.5	
Tuning Voltage Sensitivity (Kv)	MHz/V		12	
2nd Harmonic Suppression	dBc		-22	
Power Supply (Vcc) Voltage	Vdc		10	
Power Supply (Vcc) Current	mA		25	
Operating Temp. Range	°C	-40		+85

Mechanical Drawing & Pin Connections

Drawing No: MD140084-1

Top View



Bottom View



Foot Print

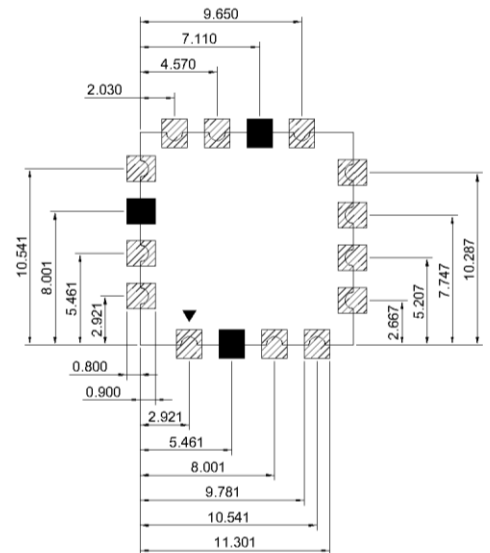

Side View



Pin Connections

2	Vt
10	RFOUT
14	Vcc
Others	GND

Unit : mm