



Features and Benefits

- Low phase noise
- Linear tuning characteristics
- Low pushing / Low pulling
- Aqueous washable

Typical Applications

- SATCOM
- Receiver
- Test Equipment
- Radar
- Point –to-Point Radio
- MMDS
- WiMax

Specifications

Parameter	Units	Min.	Typical	Max.
Operating Frequency Range	MHz	2800		3400
Output Power	dBm		7	
Phase Noise @10kHz offset	dBc/Hz		-85	
Tuning Voltage (Vt)	Vdc		2-20	
Tuning Voltage Sensitivity (Kv)	MHz/V		65	
2nd Harmonic Suppression	dBc		-10	
Power Supply (Vcc)	Voltage		8	
	Current		31	
Operating Temp. Range	°C	-40		+85

Mechanical Drawing & Pin Connections

Drawing No: MD140084-1

Top View



Bottom View



Foot Print

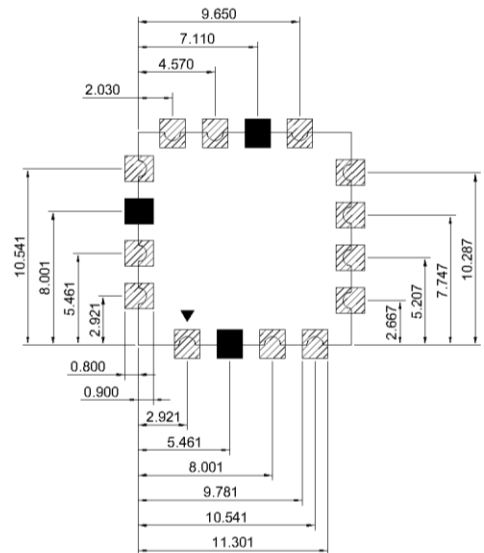

Side View



Pin Connections

2	Vt
10	RFOUT
14	Vcc
Others	GND

Unit : mm